

JVC®

The Perfect Experience

ProHD

The Professional Choice



BR-HD50 Recorder/Player

GY-HD110/GY-HD111 Compact Shoulder Camcorder

DV

HDV™

HDV 720p

Defining the future of professional video – Introducing JVC ProHD

With the introduction of JVC's ProHD, the promise of digital technology has finally been fulfilled. Surprisingly affordable, impressively professional, and remarkably compact, ProHD embraces the HDV format to deliver a complete high-definition solution that has been designed to meet the needs of today's most demanding professionals, while retaining the ability to adapt to future requirements.

Since the launch of D9 in 1996 and Professional DV in 1999, JVC has continued to develop and diversify its digital video offerings in response to the rapidly changing environment of visual communications and production. JVC continues to evolve its digital cameras and recorders with advanced features and varied storage options, including full-size DV tape and Hard Disk Drives.

Now with the production and delivery of video content starting to shift to HD, JVC has combined its expertise in camera, encoding and storage technologies to create an affordable HD solution. JVC's ProHD system, adopting the HDV format, utilises widely available non-proprietary technologies such as MPEG-2 compression, DV recording media and conventional hard disk drives. Based on input from leading end users, JVC has developed a system with the most sought-after professional features and performance. Noteworthy ProHD features include full HD progressive scanning, real 24p, and a dual recording system using tape & HDD. As ProHD evolves, it will include optical and solid state recording media.

Designed and built for professionals, ProHD is the true fulfillment of the digital promise, offering true high definition performance in a compact, affordable system.

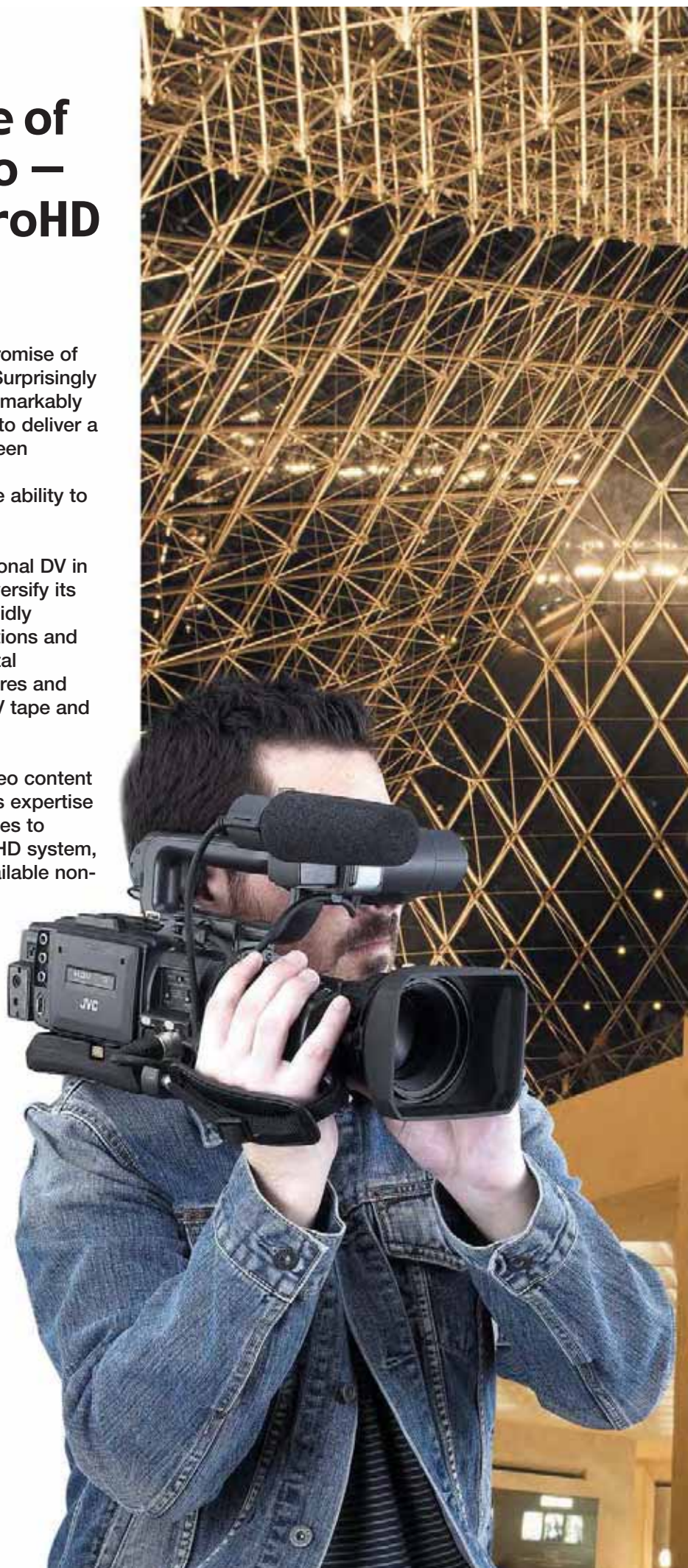



ProHD – Concept of JVC's Affordable HD Solution

1. HDV Full Progressive Scanning (720p)

Leading industry professionals told us that they wanted a progressive scanning system that would shoot and record the highest quality continuous moving images. ProHD uses the 720 progressive HDV format and produces crisp, native HD images which perfectly match today's digital displays and which can be converted easily, without degradation, to interlaced scanning pictures.

2. Time Code

As a professional system, ProHD products include the facility to record and display timecode. Convenient menu operation makes it easy to preset time code at the beginning of a tape. Simply select REC RUN or re-generation mode. User bits are also available.

3. Highly efficient video compression

To provide the highest quality HD recording, JVC uses the broadcast industry standard MPEG-2 Main Profile at HL-14. Offering far greater efficiency than frame-bound systems, ProHD records at data rates at or above commercial broadcast rates. Recent advancements in non-linear editing have made it possible to edit ProHD on virtually all popular Non-Linear systems. Direct digital transfers through IEEE 1394 ensure the quality is maintained throughout the transfer process.

4. Dual recording system

Designed to utilise both DV tape and hard disk drives, ProHD offers the ultimate in media versatility, maximising productivity with efficient, economical editing and low-cost archiving. Now you can safely archive the original tape cassette and then plug the hard disk straight into your NLE. Editing can start right away — no need to make dubs or transfer data.

5. Real 24p

With ProHD, the dream of creating HD video with the essence of film has at last been realised. By capturing and recording at the film frame rate of 24fps, and offering extensive user configurable settings such as exposure, gamma and detail, ProHD becomes an important tool for creative expression. For the ultimate expression on the big screen, 24 frame progressive recordings can be transferred easily to 16 mm or 35 mm film.



BR-HD50

GY-HD110/GY-HD111

Advantages of ProHD

1. HDV format

HDV™ HDV 720p

HDV is a video format designed to enable the recording of high definition MPEG-2 video on standard DV media (DV or MiniDV cassette tape). The HDV

format was defined by four companies: Canon Inc., Sharp Corporation, Sony Corporation, and Victor Company of Japan, Limited (JVC). The specification of the HDV format incorporates two versions, one progressive (720p) and the other interlaced (1080i). HDV uses the same track pitch and tape speed as the DV format, and therefore the recording times are the same length as the DV format.

2. HD Progressive (720p) format for high quality moving pictures and digital stills

■ Progressive scanning

The new ProHD products use the same progressive scanning system as used in all high-end HDTV cameras. Progressive scanning systems uniquely capture and store full frames of image information. It is a very simple process to convert a progressive signal to interlaced, but not vice versa. When progressive recordings are frozen or

played in slow motion, each individual frame contains the full detail of the original image — excellent for viewing and analysing motion. Stills and prints captured from HD progressive video look far better than from interlaced video. In any case, today's flat panel television displays and fixed matrix projectors, such as D-ILA, DLP and LCD, are all native progressive scanning systems. This means that JVC's progressive HDV recordings can be displayed without imperfection, because they do not need to pass through the degenerative process of de-interlacing, prior to being displayed.

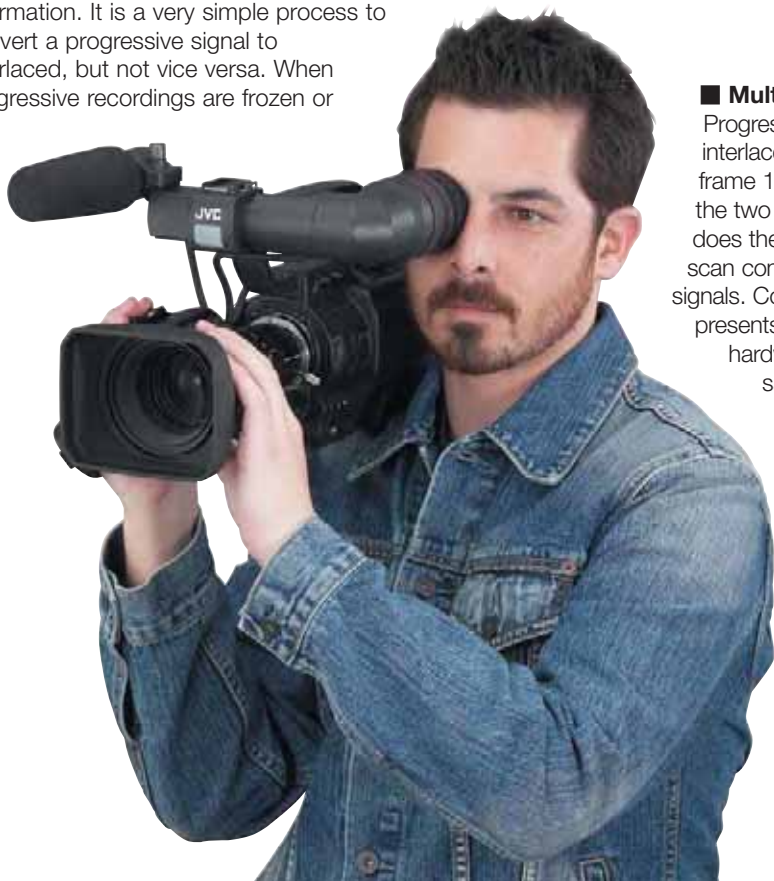

■ Multi-format output (BR-HD50)

Progressively scanned pictures are converted easily to the interlaced format by extracting the odd lines from progressive frame 1 and the even lines from progressive frame 2 to create the two fields required for each interlaced frame. Not only does the BR-HD50 output its native 720p, but also its built-in scan converter can generate 1080i and standard definition signals. Converting the other way, to progressive from interlaced, presents a much greater technical challenge, requiring both hardware and motion analysis software to achieve satisfactory results.

■ Blu-ray and HD-DVD compatible

The IEEE 1394 connector provides a digital output for editing & recording and for direct transfer to the new generation DVD formats (Blu-ray and HD-DVD). ProHD camcorders and recorders, with their native MPEG-2 TS (Transport Stream), provide a recording signal which is easily transferred to these new DVD formats. This ensures no loss of picture quality.

■ HDV and DV compatibility

The HDV format uses the same recording track pitch (10 µm) as Professional DV, meaning that ProHD also offers track pitch compatibility with the DV format and the same recording time. This remarkable HD recording capability was achieved by developing a new high-power MPEG codec system capable of maintaining high-definition picture quality, whilst compressing the data to 19.7 Mbps bit rate. With its superior resolution and advanced processing, ProHD delivers top performance in both its native 16:9 HD mode and in the SD mode. The facility to make recordings in either HD or SD makes ProHD the ideal choice for professionals not quite ready to make the full transition to HD.

■ Progressive HDV-compatible support

To maximise picture quality and performance from input to output, JVC employs the HDV 720 progressive system. Progressive HDV's resolution of 1280 x 720 is the same as the native resolution of most HD display devices in use today (LCD, plasma, DLP, D-ILA). HDV 720p is thus natively compatible in terms of both resolution and scanning system with the vast majority of today's HD displays.



The GY-HD110, fitted with Mini 35 film adapter from P & S Technik, becomes a digital film camera.

3. Real 24p

24p Progressive Full HD images are ideal for cinematographic applications. From shooting to editing and distribution, an HD system can be established for film-like productions. Unlike 24p images in standard definition, when real 24p HD video is down-converted to SD, the result is truly film-like DVDs. The camcorder itself, with its video lens removed and replaced by a film lens converter system, such as the Mini 35 from P & S Technik, effectively becomes a digital film camera.

4. JVC's dual recording system

The optional JVC Hard Disk Recorder DR-HD100 creates a dual recording system of tape and hard disk. This system is already utilised by Professional DV users the world over. The many advantages inherent in JVC's dual recording system of tape & hard disk drive are well appreciated. It was only natural that JVC's range of ProHD models would include a Hard Disk Drive recorder and one that can operate equally in DV and HDV modes. The dual recording system provides fast and efficient HDD-based editing and cost-effective archiving, using low-cost tapes. Thanks to the newly developed MPEG-2 encoding IC, high-quality pictures can be recorded on readily available compact DV cassettes, so running costs are minimal. As no special equipment or exclusive media are required, the operating costs of the total system can be kept low. The DR-HD100 is mounted at the rear of the camcorder, utilising an optional bracket which is provided by the leading battery systems manufacturers.

What's new on GY-HD110 and GY-HD111 (compared with GY-HD100)

- **Black & white viewfinder display mode**
- **Simultaneous use of both eyepiece viewfinder and tri-mode LCD display when powered by Anton Bauer, IDX or PAG battery system**
- **Selectable mirror mode on vertically flipped LCD display**
- **Adjustable setting of FOCUS ASSIST function**
- **Choice of 3 image formats on composite out (letterbox, squeeze, side cut)**
- **User-adjustable DNR level menu setting**
- **13 segments audio level indicator**
- **Manual audio control within FAS (Full auto shooting) mode**
- **Audio limiter available in manual mode**
- **Parallel off power management of DR-HD100 recorder (GY-HD111 only)**



GY-HD110 Outputs and Applications

Signal: **576i digital component throughout.**

Standard Definition Production

Application: **Integration with existing SD editing equipment plus additional facility for true native 16:9 origination.**

The compact size and wealth of professional features of the GY-HD110 apply just as much to the SD user as to those working in High Definition. Existing DV equipment and accessories can continue to be used with the GY-HD110. However its three CCDs with 1280 x 720 pixel resolution ensure high quality images with superb colourimetry in

both widescreen 16:9 modes and also in a standard 4:3 aspect ratio.

For those upgrading in the future to High Definition, the GY-HD110 will provide a seamless link from the

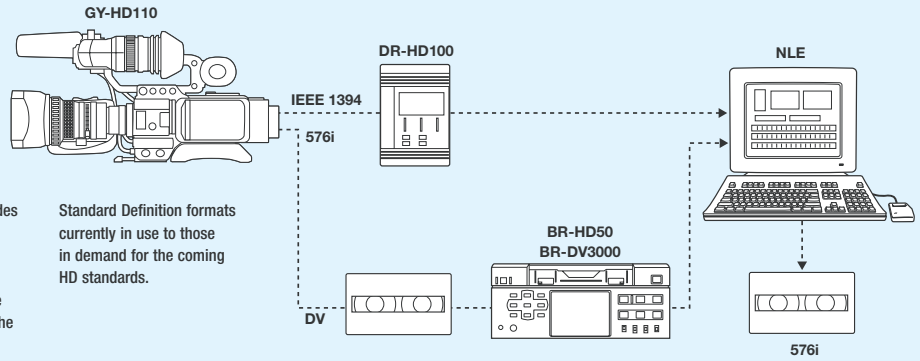

Standard Definition formats currently in use to those in demand for the coming HD standards.

Signal: **720p 24.**

Film School

Application: **Acquisition for cinematography, transfer to film & video assist.**

From the native uncompressed 720p signal, the GY-HD110 camcorder can be set to generate the HDV6 compliant 720p 24 recording signal which can record to cassette or to hard disk recorder. The recordings can then be fed in and out of an appropriate NLE and so to a film laser printer, without any requirement for cross-conversion, either from 25p by way of 4% speed change or from 30p by process of 3:2 pull-down.

A further advantage of the GY-HD110 for film schools is that accessories allow the camcorder to be transformed into a digital film camera. The PL-mount adaptor allows prime film lenses to be deployed and also a matte box. Since the optional add-on DR-HD100 hard disk recorder will also record the HDV6 for mat of 720p 24, many hours at a time can be put in the can.

For the film shooting application of ivideo assist, even standard definition recording can be set to 24p progressive to capture perfectly the film effect.

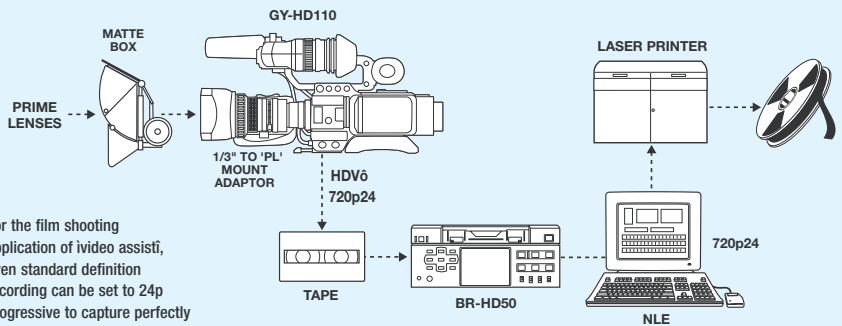

Signal: **720p 60/50, 720p 30/25, 1080i 60/50, and 576i 50.**

Multi Standard Flexibility

Application: **Various, where material is to be matched with existing footage or images captured on another format.**

The diagram shows the video signals that are commonly found in HD and SD production in Europe. Specifically this diagram illustrates how these signals are directly available from either the GY-HD110 or the BR-HD50 via a tape recorded in the native 720p 30/25 format on either of these devices.

This flexibility comes in part as a result of the original material being recorded in a progressive format, which allows for easier and more effective conversion to other formats than if the original had been recorded as an interlaced signal.

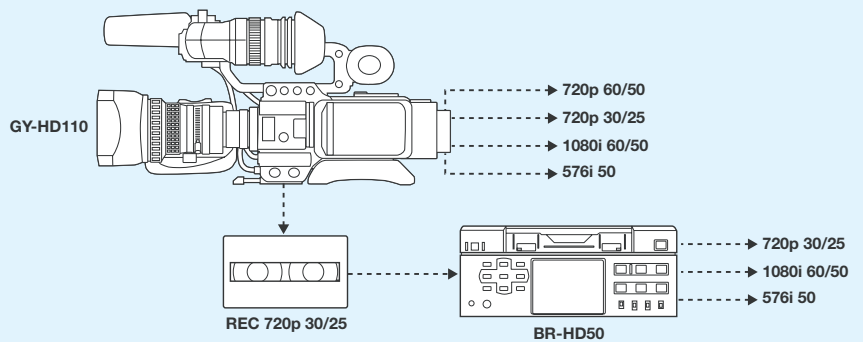

Signal: **720p 50 and 720p 60 uncompressed HD.**

Live HD

Application: **Live event broadcasting and recording.**

The signal natively generated inside the GY-HD110 is the uncompressed 720p progressive HD format, selectable as either 720p 50 or 720p 60. This signal is available as a live output direct from the camera head. This is ideal for the generation of live pictures at sporting or music events, or indeed at any event where live HD broadcasting is required.

In a typical live application the uncompressed 1280 x 720 progressive signal will be encoded to HD SDI for feeding into a video server, an HD switcher or a microwave link.

Added flexibility is given to the production company or broadcaster because the European model GY-HD110 is switchable between 720p 50

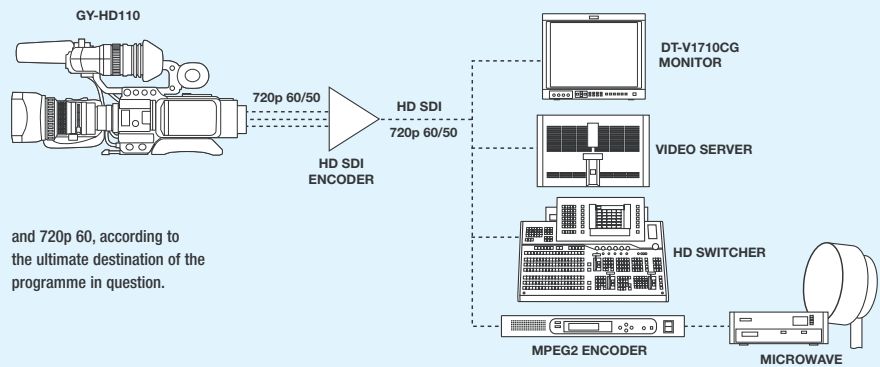

and 720p 60, according to the ultimate destination of the programme in question.

Signal: **720p 25 and 720p 30 and 720p 24.**

HD Acquisition

Application: **Acquisition for HD.**

From the native uncompressed 720p 50 or 720p 60 signal, the GY-HD110 camcorder generates an HDV6 compliant recording signal. The choice of selectable HDV6 recording signals is from 720p 25, 720p 24 and 720p 30 which can be sent to either the built-in tape cassette or to the add-on hard disk recorder, or to both at the same time. The recordings can then be fed directly into an NLE for editing purposes. The progressive nature of the pictures allow for easier

translation into interlaced formats if so required.

A low cost way to archive the HD footage from both the MiniDV cassettes and the hard disk recorder, or indeed from the NLE itself, is to dub it across to the BR-HD50, which records HD on standard size DV cassettes up to 4.6 hrs in length.

Also, if the camcorder and recorder are being used to achieve precise cinematographic effects, then recording in 720p 24 is available.

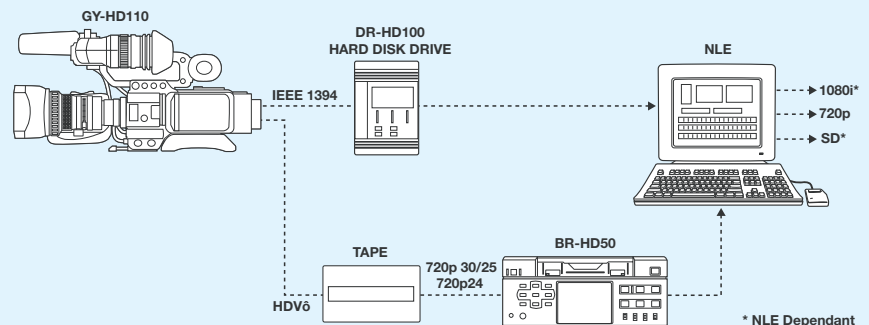

Signal: **720p 30/25.**

HD Acquisition & Archive with SD Delivery

Application: **Delivery of the same video programme in SD today and in HD tomorrow, using same source footage.**

Whilst today's client may only want a standard definition DVD copy of the corporate promotion, wedding or sporting event, there is good reason to originate the footage in HD. With the increasing development of HD in the consumer arena, future copies or versions may be produced which will benefit from the larger flat panel displays and consumer playback devices which will all

be capable of high definition storage and display.

With HDV being recorded on exactly the same mini and standard-size cassettes as professional DV (Standard Definition), the archiving of HD footage on tape cassettes is very cost-effective. The GY-HD110 takes the mini cassette with more than 1-hour's duration and the

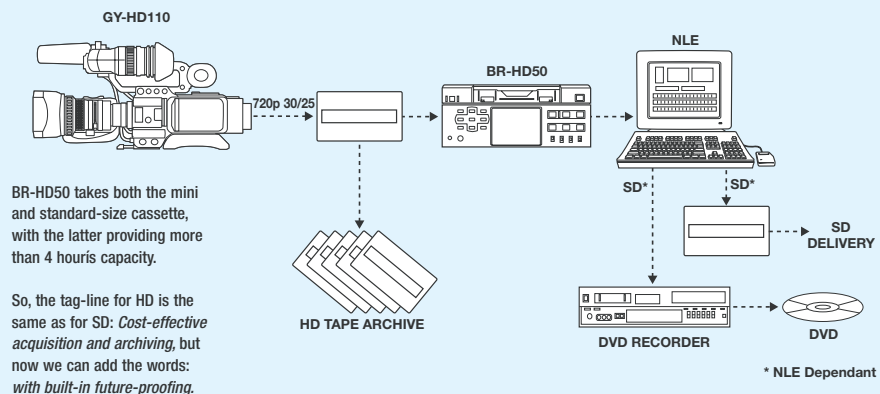

BR-HD50 takes both the mini and standard-size cassette, with the latter providing more than 4 hours capacity.

So, the tag-line for HD is the same as for SD: *Cost-effective acquisition and archiving, but now we can add the words: with built-in future-proofing.*

Note: GY-HD110 and BR-HD50 cannot be used as a 60 Hz — 50Hz converter.

Totally professional compact shoulder camcorder with Full Progressive HD and Real 24p

Interchangeable HD lenses

720p/50 & 720p/60 live outputs

LCD colour viewfinder and LCD panel

Compact shoulder mount

ProHD lens

- Detachable HD zoom lens (Bayonet mount)
- Mechanical control of zoom, focus and Iris



Actual Size

Optional lens accessories

- Matte Box
- Filter kit
- Wide angle converter
- 1/2-inch and 2/3-inch bayonet mount converters available from JVC

GY-HD110
GY-HD111

ProHD Compact Shoulder Camcorder (HDV/DV output only)
ProHD Compact Shoulder Camcorder (HDV/DV Input/output)



Professional viewfinder

- Detachable professional eyepiece colour viewfinder, switchable to monochrome
- Patented "FOCUS ASSIST" function enables fast, easy and accurate focusing in both the viewfinder and LCD display, especially useful for HD shooting

ProHD

As the first HD camcorder to feature a 1/3" bayonet mount for interchangeability, this 3-CCD HDV and DV camcorder is compatible with a wide selection of HD lenses. Its compact design, comprehensive professional features and excellent portability make the GY-HD110 today's most affordable professional HD video acquisition device.



Professional specifications

HDV and DV compatible

As the HDV format uses the same recording track pitch as Professional DV, the GY-HD110 can record signals in either standard or high definition according to the user's needs.

Real 24p camcorder

The GY-HD110 is a professional high-definition camcorder featuring real HD 24p recording capability — previously available on only the most expensive HD cameras. With HD progressive 24 frame per second recording, images can be shot with film-like quality and smooth motion which is ideal for DVD production.

Interchangeable HD lenses

The GY-HD110 features a standard professional 1/3" bayonet lens mount that allows the use of other professional HD lenses. By using the optional mount adapters, it is possible to use existing 1/2" and 2/3" bayonet mount lenses.

3-CCD camera system with new 720p HD CCDs

The GY-HD110 uses three newly developed 1/3" high definition CCD image sensors, each array has a pixel resolution of 1280 x 720 and uses a micro lens system. Since this native resolution matches that of most HDTV displays, the need for image scaling is eliminated, further enhancing the quality of the recorded images. Other advantages of these CCDs include sophisticated circuitry that virtually eliminates lag and image burn.

Uncompressed 720p/50 and 720p/60 live signal output

In addition to providing superior quality HD recording in the 24p format, the GY-HD110 can output an analogue component 720p HD signal at 50 or 60 frames per second which is ideal for live broadcasting. Via a third-party HD SDI converter, the uncompressed full-resolution signal can be fed into a video server, HD switcher or microwave link.

Two XLR audio inputs

To record high-quality digital audio, the camcorder has two XLR connectors with independent controls for each channel.

Professional functions

Compact shoulder mount

The first fully professional HD camcorders to be of compact design and to feature a shoulder mount, the GY-HD100 and now the GY-HD110 offer excellent mobility and enhanced usability. The range of ergonomic adjustments ensures that any camera operator, regardless of their stature and physique, can support the camcorder firmly and, above all, comfortably.

Professional functions and switch layout

In addition to the Full Auto Shooting to handle difficult or variable lighting environments, the GY-HD110 is equipped with an array of functions that give professionals creative flexibility. These include, amongst others, zebra, gain, white balance and full shutter control. Also, the GY-HD110's switches have been positioned where professional camera operators expect them to be. Shooting is intuitive, precise, easy, and error-free, because there is no learning process to go through. The GY-HD110 is the ideal camera for any assignment.

SD memory card

- Camera setups can be stored on an SD card, allowing more flexibility and faster set-up in the field

External HDD Capability

- HDD recording of HD pictures possible via optional 40GB or 80GB version of DR-HD100, giving 3-1/2 and 7 hours recording times respectively
- With DTE™ (Direct to Edit) technology, video, audio, time code and control information can be directly transferred from the camcorder into an NLE system, or the HDD instantly transforms into a source drive

GY-HD110 GY-HD111

ProHD Compact Shoulder Camcorder (HDV/DV output only)
ProHD Compact Shoulder Camcorder (HDV/DV Input/output)

HDV™

HDV 720p

Professional Quality

- Rugged die-cast metal alloy body
- Sliding shoulder pad
- Adjustable stabiliser pad with audio monitor



Professional functions (cont'd)

Full Auto Shooting

In an emergency, or when there is no time to pause and adjust the white balance or change the gain, the Full Auto Shooting mode provides simple point-and-shoot operation, leaving the operator only to zoom, focus, and press the record button. Activating Full Auto Shooting puts the camera into the Auto Iris mode, even when the lens is set to manual. Automatic Video Level Control (ALC) is also activated, along with Extended Electronic Iris (EEI), providing both variable gain and variable shutter and Full Auto White to follow any changes in colour temperature. This means that you can shoot continuously from darkness into bright light, from indoors to outdoors, without having to adjust gain, iris, white balance or ND filter. On the other hand, you can control the audio level during Full Auto Shooting, manually adjusting it as desired.

Colour matrix

A sophisticated six-axis colour matrix circuit is effective in compensating for any colour aberrations caused by the lens optics. This is most important with interchangeable lenses to ensure natural and faithful tones at all times. Several colour matrix presets are provided to give more creative control over the look and feel of the video content.



Detachable 230,000-pixel LCD colour viewfinder

The viewfinder's eyepiece can be moved backwards and forwards and can also be adjusted laterally for left or right eye shooting, so the viewfinder can fit any operator comfortably. JVC's own developed Focus Assist control (see this page) ensures fast and easy focusing. To make focusing even easier, a black and white mode is available. Stronger contrast and reduced colour noise make visualisation and composition easier in this mode and put less strain on your eyes so you can shoot for longer periods. You can also keep using the viewfinder even when using the LCD display. If not required, the viewfinder may be detached.

3.5" LCD display panel*

This 250,000-pixel 3.5" colour TFT LCD monitor provides a high-resolution image during shooting and playback. JVC's own developed Focus Assist control (see this page) ensures fast and easy focusing. A push button selects three display modes:



1. Video only
2. Video images with text information overlay including time, status, mode and other data are shown on the screen.
3. Only information such as time, status, mode, time code, audio levels and other data is shown on the screen. When the LCD display panel is in this mode, the viewfinder can also be used.

*When powered by Anton Bauer, IDX or PAG battery system.

LCD mirror mode

When the LCD panel is rotated towards the subject, mirror mode can be selected to display an image on the LCD screen, which, in terms of left and right, is exactly the same as the image in the eyepiece viewfinder. This is a very useful feature for TV news reporters when talking to camera on a self-operated video reporting system. Normal or Mirror mode is selected in the menu.

Various audio-related functions

When colour bars are output, an audio reference level (test tone) can also be output if required. This is requested via the menu. The audio reference level can be set at -12 dB or -20 dB as required. To minimise extraneous noise picked up by the microphone, a "wind cut" function is provided.

Versatility and flexibility

Real-time playback capability

Because the GY-HD110 is able to convert the recorded HDV 720p signal to other different HD signal types, and do the conversion in real time, it is a very fast and versatile HD device, which is able to maintain HD signal quality at all times.

Easy transfer to 16 mm or 35 mm film

Specially designed to facilitate transfer to 16 mm or 35 mm film, the GY-HD110 enables recordings to be transferred with full HD fidelity, without frame rate conversion.

Camera settings recorded on SD card

Customised settings can be stored on a standard SD memory card and loaded into another GY-HD110 or changed on site, as required.

IEEE 1394 interface

A convenient IEEE 1394 bus interface makes for easy direct connection to NLE systems or to a PC for downloading, editing and archiving.



Three-mode composite out

To display the image, three modes (Letterbox, Squeeze and Side Cut) are available.

Letterbox: Masks upper and lower parts of the image.

Squeeze: Squeezes the image electronically.

Side Cut: Cuts off the right and left sides of the image.

User-friendly design

Universal ergonomic design

Adapts to fit anybody comfortably because of the shoulder pad that can be moved back and forth, the left-eye right-eye viewfinder with eyepiece that can also be adjusted back and forth, and the padded audio monitor that adjusts up & down.



Patented "FOCUS ASSIST" function

A JVC patented device, Focus Assist, turns focusing into an easy, fast and accurate process. When Focus Assist is activated, the picture in the viewfinder becomes monochrome and all objects which are in focus take on a coloured fringe. In addition to the factory default Middle position, Low and High positions are available. In the Low position, you can limit the area in focus for more precise focusing. This is particularly helpful when using the technique of pulling focus. Focus Assist works equally in the 0.44" viewfinder and the 3.5" LCD panel. There are two Focus Assist buttons, one for each of handheld and shoulder operation.



Out-of-focus image



In-focus image

The edge of the in-focus subject is shown in colour, telling the operator that the subject is in focus. One main benefit of this system is that it operates in real time.

Variety of optional lenses

In addition to a standard detachable 16x servo Fujinon lens, a wide range of options are available, including a 13x (3.5 mm) wide zoom lens, a wide angle converter for the standard 16x lens, and adapters that allow 1/2" and 2/3" bayonet mount lenses to be used.

Cinema mode

Cinema mode colour is available in the set-up menu, which automatically adjusts the gamma curve and colour matrix to give that film look.

Connect to the optional external HDD

The camcorder has a hard disk drive accessory option, DR-HD100, which connects via the IEEE 1394 port, allowing footage to be edited immediately without having to wait for data to be transferred.

Colour bars

A colour bars generator is built in.

Other features

- Black stretch & black compress
- Full Auto White (FAW)
- Iris level adjustment
- Detail correction
- Detail V & H balance
- Skin detail detection
- White clip select
- Knee point select
- 7.5 IRE setup ON/OFF
- Locked audio (16-bit, 48 kHz only)
- Automatic level control (ALC)
- System file selection
- Variable, slow shutter
- Gamma control
- Auto black level

DR-HD100 Hard Disk Drive incorporating the latest DTE (Direct to Edit™) technology

Connects to GY-HD111 camcorder

The DR-HD100 has been designed specifically to attach to the GY-HD111 camcorder. Interlocked to the camcorder's record trigger, HD and SD images can be recorded together with audio and time code. It is powered by either a built-in rechargeable or an external battery. The DR-HD100 is supplied with its own cradle, from which it is detached easily. Optional bracketry is available for mounting the HDD recorder at the rear of the camcorder.

Compatible with popular NLE systems for HDV and DV editing

DTE™ technology permits the DR-HD100 recording data in HDV and DV to be set to the NLE's native file format. This means that no time is lost to the lengthy processes of file transfer and rendering. Use DR-HD100 instantly with the most popular applications from Adobe, Apple, Avid, Canopus and many more. As new application support is released, the DR-HD100 can be updated in the field with new system software, by an easy process using the disk drive itself.

Integrated with camcorder and disk drive operation

Attached with the GY-HD111, the DR-HD100's record and record/pause functions are controlled from the camcorder. Time code generated by the camcorder is recorded to files on the DR-HD100 and DR-HD100 status and other information appears in the viewfinder and LCD display.

Long record times

This hard disk drive option extends uninterrupted record time by hours. For example, an 80GB FireWire drive can store 6 hours of DV video and 7.5 hours of HDV video, and a 40GB drive does half these times. It is possible also to daisy chain up to four external drives of different capacities to the DR-HD100, enabling uninterrupted recording of incredibly long durations.

LCD display and playback modes

The DR-HD100 features a detailed LCD that displays system mode, time code and disk space remaining. When used with the GY-HD111 camcorder (with external HDV & DV input) clips can be reviewed on the viewfinder, LCD panel or external monitor, by using DR-HD100's playback mode. Functions include record, play, pause, stop, forward index, back index and multi speed fast forward and rewind.

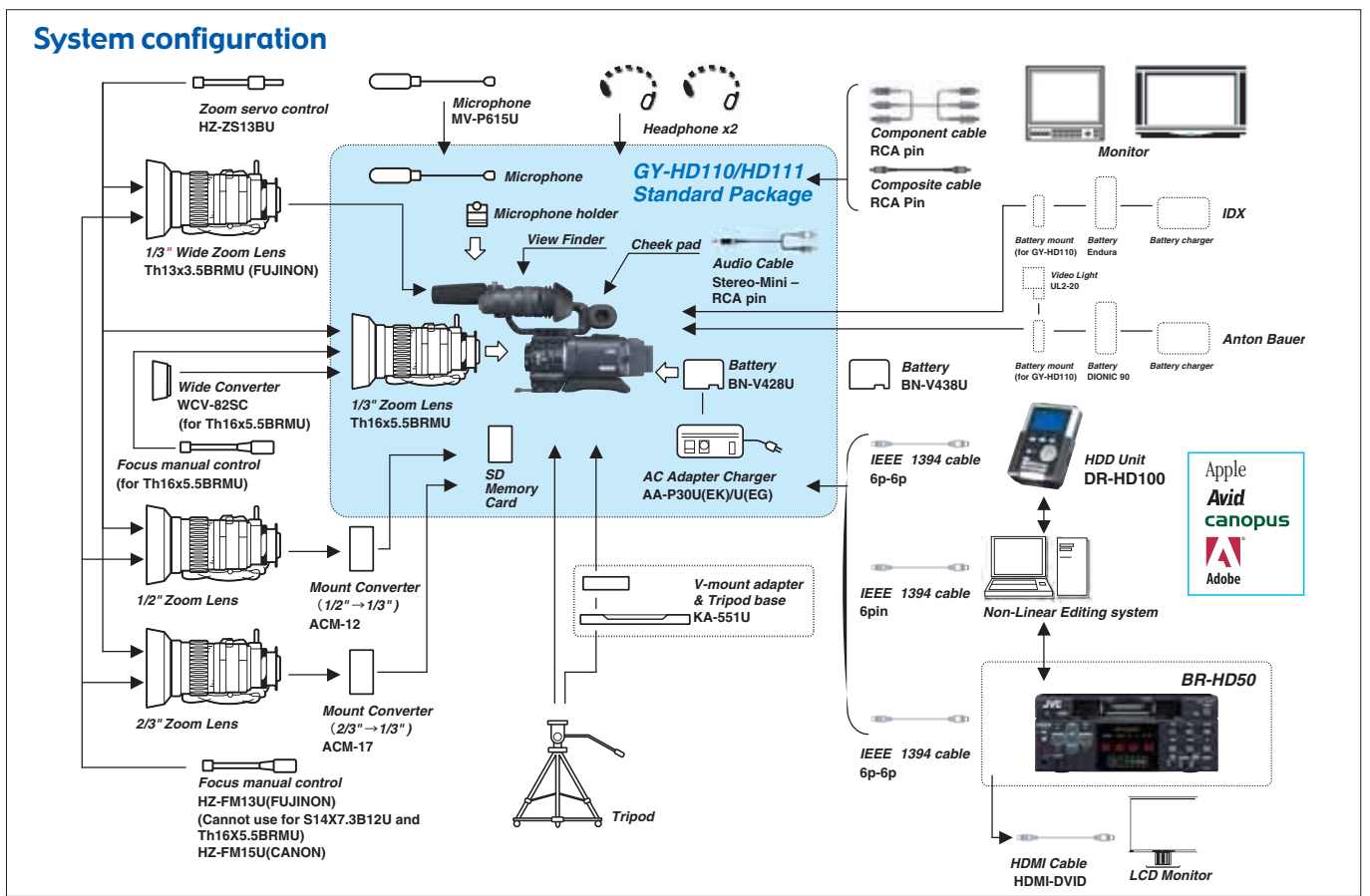

BR-HD50

ProHD Recorder/Player

HDV™

HDV 720p

DV



Advanced HD performance in a compact, uncomplicated

The companion model to the GY-HD110, this HDV and DV recorder / player is designed to transfer video and audio data to an NLE editing system. Optimised for use with a wide variety of existing systems and formats, this unit features switchable HDV and DV modes and analogue outputs. It can connect also to a plasma or an LCD panel equipped with an HDMI connector and be used as a low-cost viewer. With its low cost and high flexibility, the BR-HD50 is ideal for any facility looking for a smooth upgrade path from standard definition to high definition production.

Professional design

HDV recording

As the HDV format uses the same recording track pitch as Professional DV, the BR-HD50 can record signals in either standard or high definition depending on the user's needs.

Multi-format output and Cross-converter function

A sophisticated cross-converter function enables output of not only 720p signals, but also 1080i, 576p and 576i signals. So, thanks to switchable HDV and DV recording modes, plus DVCAM playback, this recorder / player is a real asset for any existing editing system.

HDV 60Hz and 50Hz compatibility

Switch between HDV 60 Hz or 50 Hz as required. This makes it easy to work with internationally sourced material and transfer it to a non-linear system for editing. You can also record to Standard DV or Mini DV tape in either HDV 60 Hz or 50 Hz.

*Cannot be used as an HDV 60 Hz - 50 Hz converter. The BR-HD50 can record and play back signals in both HDV 60 Hz and 50 Hz formats.

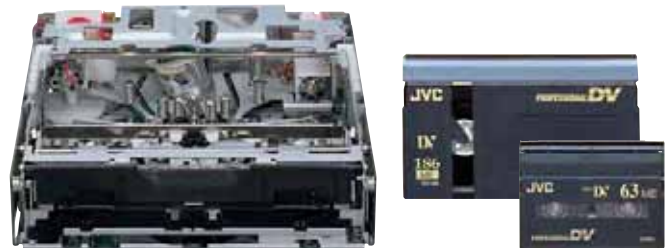

Recording system

The BR-HD50 can record signals in 720p/24, 25 & 30, 480p/60 & 576p/50 and in 576i/50 & 576p/25.

Standard DV & Mini DV compatible mechanism

Proven on JVC's Professional DV recorders, this mechanism not only provides high stability, but also accommodates both Standard DV and Mini DV cassettes without the need for a cassette adapter.

DVCAM playback capability

DVCAM recordings can be played back directly on the BR-HD50 in SD mode. This means that DVCAM recordings can easily be used as source material for editing.

Stable high picture quality

Auto error correction system

JVC has developed an auto error correction system that operates on a frame-by-frame basis to ensure accurate error compensation during playback. After optimally calibrating the playback RF waveform with a pre-filter circuit, the VCO (voltage control oscillator) voltage is



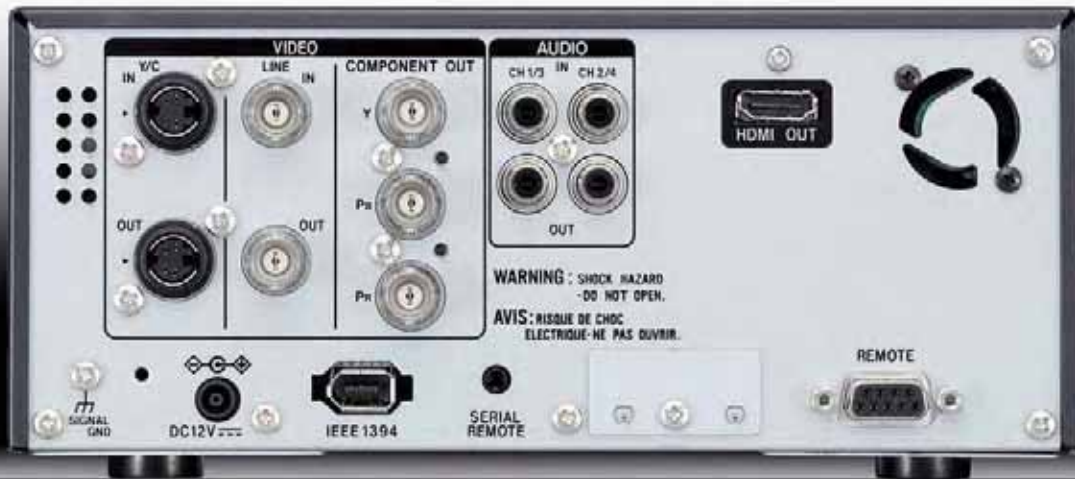

recorder/player with multi-format video output

changed so that the data reading of the clock phase is shifted to the position where the error rate is lowest. The result is accurate, consistent suppression of block noise and reliable, professional standard performance at all times.

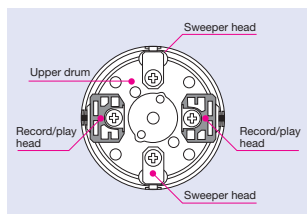

Sweeper heads

During recording and playback, to reduce the block noise which is caused by dust adhering to the heads, JVC's HDV & DV camcorders and recorders incorporate an advanced drum assembly with specially designed "sweeper" heads. These dummy heads sweep off any magnetic material dropped by the tape or any dust that may have entered from outside the unit.

Various interfaces

HDMI OUT

The BR-HD50 is equipped with an all-in-one HDMI output for direct digital connection to the latest high-definition projector and LCD displays.

RS-422A interface

For compatibility with the widest range of editing systems, the BR-HD50 is equipped with an industry-standard RS-422A interface, allowing easy integration with high-grade NLE systems.

IEEE 1394 interface

For lossless dubbing and recording of both HD and SD programmes, compressed HD (MPEG-2) or SD (DV) digital signals can be input or output to or from external devices such as a non-linear editing system. A front panel switch allows easy switching between SD and HD.

Versatile analogue connections

In addition to IEEE 1394 input & output, the BR-HD50 is equipped with

BNC connectors for analogue component output in HD and SD and also for composite input & output. Y/C input & output connectors are 4-pin mini DIN.

User-friendly design

Large full counter

A big 8-digit LED display on the front panel displays time code, user bits and VTR status.

Audio indicator

This indicator lights up whenever audio signals are input. Also, it provides a convenient way to check for the presence of audio signals during tape playback.

High-speed time code search & blank search

The built-in time code generator provides preset, rec run and regen time codes. The DV 20x search function (100x max. in the FF or REW mode) and the HD 8.5x forward search function (6.5x in reverse), provides super-fast access to any desired point on the tape.

Continuous recording

When a camcorder is connected to the BR-HD50 via the IEEE 1394 connector, the BR-HD50 will start recording 5 minutes before the tape in the camcorder ends. This enables continuous shooting for extended periods with no breaks in the recording.

On-screen menu

Systematic, easy-to-understand menu screens simplify set-up and operational procedures. Menu setting is performed via the buttons on the front panel.

Other features

- Lock audio (16-bit, 48 kHz only)
- Time code reader / generator
- Headphone connector
- Contact closure recording
- Repeat playback
- Wired remote control

Options and related equipment

CAMCORDER OPTIONS

<p>1/3" Wide zoom lens</p>  <p>(Fujinon)</p> <p>■ Th13x3.5BRMU</p>	<p>1/3" Zoom lens</p>  <p>(Fujinon)</p> <p>■ Th16x5.5BRMU</p>	<p>2/3" Bayonet mount converter</p>  <p>■ ACM-17</p>	<p>1/2" Bayonet mount converter</p>  <p>■ ACM-12</p>	<p>Wide converter</p>  <p>■ WCV-82SC</p>
<p>AC adapter/Battery charger</p>  <p>■ AA-P30U(EG)/U(EK)</p>	<p>Lithium-ion battery</p>  <p>■ BN-V428U (DC 7.2 V, 2800 mAh) ■ BN-V438U (DC 7.2 V, 3800 mAh)</p>	<p>Anton Bauer battery</p>  <p>■ QR-JVC7/14HDV (Adapter) ■ Titan70 (Charger) ■ Dionic90 (Battery)</p>	<p>IDX battery</p>  <p>■ A-E2HD100 (Adapter) ■ VL-2 (Charger) ■ Endua E-7S (Battery)</p>	<p>PAG battery</p>  <p>■ 9522/75 (Adapter) ■ 9613 (Charger) ■ 9382L95 (Battery)</p>
<p>Tripod base V-mount adapter</p>  <p>■ KA-551U</p>	<p>Microphone</p>  <p>■ MV-P615U</p>	<p>Manual zoom control</p>  <p>■ HZ-ZS13BU ■ HZ-ZS100U (Handle zoom)</p>	<p>Manual focus control</p>  <p>■ HZ-FM13U* (Fujinon) ■ HZ-FM15U (Canon)</p> <p><small>*The HZ-FM13 cannot be used for S14 and Th16 lenses. Use Fujinon FMM-8; Module unit/CFH-3; Grip/CF-12-990; Cable</small></p>	<p>Film lens adapter Mini 35 from P&S Technik</p> 

ProHD TAPES

 <p>■ M-DV63PROHD ProHD tapes (miniDV size) ■ M-DV12CL MiniDV cleaning tape</p>	 <p>■ LA-124PROHD ■ LA-186PROHD ■ LA-276PROHD</p>
--	---

HARD DISK DRIVES



■ **DR-HD100-40**
■ **DR-HD100-80**

MONITORS



■ **DTV-1710CG**
■ **GM-H40L**

DIMENSIONS

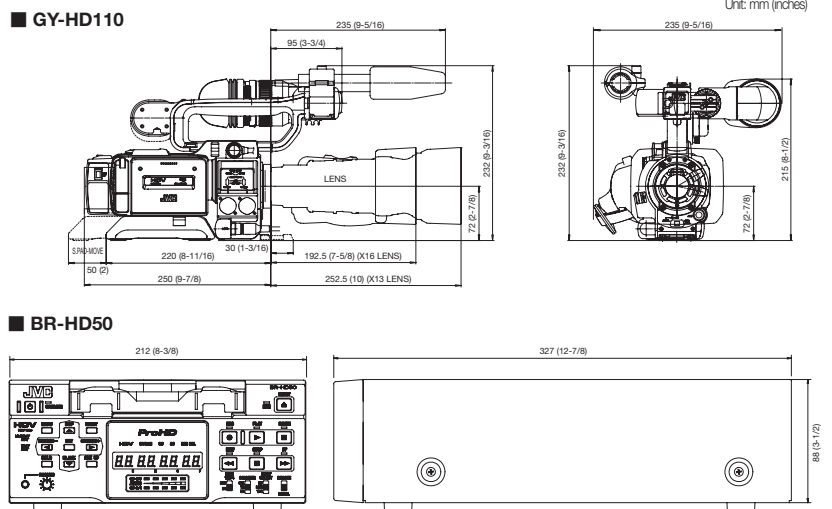

Specifications

GY-HD110/GY-HD111

[General]

Power requirement: DC 7.2 V
 Power consumption: Approx. 17 W (in the Record mode)
 Dimensions: 235 (W) x 232 (H) x 315 (D) mm
 Weight: 3.1 kg (including lens (Th16x5.5BRMU), viewfinder, battery, microphone and tape)
 Temperature:
 Operating: 0°C to 40°C
 Storage: -20°C to 60°C
 Humidity:
 Operating: 30% to 80% RH
 Storage: 85% RH or less

[Camera section]

Image pickup device: 1/3" interline-transfer CCDs
 Colour separation optical system: F1.4, 3-colour separation prism
 Number of pixels: Total: Approx. 1,110,000 pixels
 Colour system: PAL (wideband R-Y, B-Y encoder)
 Colour bars: EBU type
 Sync system: Internal sync (built-in SSG)
 Lens mount: 1/3" bayonet system
 ND filter: +1/4ND, +1/16ND
 Sensitivity: F8, 2000 lx (typical)
 Minimum illumination: 6 lx with F1.4, at 18dB
 Gain: 0, 6, 9, 12, 15, 18 dB, ALC
 Electronic shutter:
 Standard value: 50 Hz
 Fixed values: 6.25-10,000 Hz 11 steps HDV HD25p/HDV SD50p/DV 50i mode, 6.25-10,000Hz, 11 steps (DV 25p)
 Variable scan: 50.2 to 1,973.7 Hz, 48.12-1,998.0Hz HDV 24p
 Dynamic range: 300 % or more

[VTR section]

Video

Recording format: 720/24p, 720/25p, 720/30p, 576/50p, 480/60p, 576/25p, 576/50i

Video Format

[HDV]

Video signal recording format: HDV720p format, 8-bit, 19.7 Mbps
 Compression: MPEG-2 video (profile & level: MP@H-14)
 Sampling frequencies: 480/60p: 27 MHz (4:2:0 component), 576/50p: 27 MHz (4:2:0 component), 720/60p: 74.25/1.001 MHz (4:2:0 component), 720/50p: 74.25 MHz (4:2:0 component), 1080/60i: 74.25/1.001 MHz (4:2:0 component, up conversion only), 1080/50i: 74.25 MHz (4:2:0 component, up conversion only)

[DV]

Video signal recording format: DV format, 8-bit, 25 Mbps
 Compression: DV compression, 4:2:0

Audio

[HDV]

Audio signal recording format: MPEG1 Audio Layer II

[DV]

Audio signal recording format: 16-bit (locked audio), 48 kHz PCM for 2 channels or 12-bit, 32 kHz PCM for 4 channels
 Usable tape: Mini DV tape
 Tape speed: 18.831 mm/sec.
 Record/play time: 63 minutes (with an M-DV63PROHD tape)

[Connectors]

Analogue composite output: 1.0 V (p-p), 75 ohms, unbalanced (RCA)

Analogue component output:

Y: 1.0 V (p-p), 75 ohms, unbalanced (RCA)

R-Y/B-Y: 0.7 V (p-p), 75 ohms, unbalanced (RCA)

Audio inputs:

Mic: -60 dBs, 3 kohms, balanced (XLR), +48 V output for phantom power supply

Line: +4 dBs, 10 kohms, balanced (XLR)

Audio outputs: -6 dBs, low impedance, unbalanced (stereo mini-jack)

Earphone jack: -17 dBs to -60 dBs, 8-ohm impedance (stereo mini-jack x2)

IEEE1394 connector: 6-pin

[Accessories provided]

Battery (BN-V428), AC adapter/battery charger (AA-P30), AC cable, DC cable, Lens (Th16x5.5BRM), Microphone, Audio cable, SD memory card

BR-HD50

[General]

Power requirements: DC 12 V (from provided 12 V, 3.5 A AC adapter)
 Power consumption: Approx. 20 W
 Dimensions: 212 (W) x 88 (H) x 327 (D) mm
 Weight: Approx. 3.9 kg
 Temperature:
 Operating: 5°C to 40°C
 Storage: -20°C to 60°C
 Humidity:
 Operating: 30% to 80% RH
 Storage: 85% RH or less

[Video]

Recording format: 720/24p, 720/25p, 720/30p, 576/50p, 480/60p, 576/25p, 576/50i

Video Format:

[HDV]

Video signal recording format: HDV720p format, 8-bit, 19.7 Mbps
 Compression: MPEG-2 video (profile & level: MP@H-14)
 Sampling frequencies: 480/60p: 27 MHz (4:2:0 component), 576/50p: 27 MHz (4:2:0 component), 720/60p: 74.25/1.001 MHz (4:2:0 component), 720/50p: 74.25 MHz (4:2:0 component), 1080/60i: 74.25/1.001 MHz (4:2:0 component, up conversion only), 1080/50i: 74.25 MHz (4:2:0 component, up conversion only)

[DV]

Video signal recording format: DV format, 8-bit, 25 Mbps

Compression: DV format, 4:2:0

[Audio]

[HDV]

Audio signal recording format: MPEG1 Audio Layer II

[DV]

Audio signal recording format: 16-bit (locked audio), 48 kHz PCM for 2 channels or 12-bit, 32 kHz PCM for 4 channels

Usable tape: Standard/Mini DV tape

Tape speed: 18.831 mm/sec.

Record/play time: 276 minutes (with LA-276PROHD tape),

63 minutes (with an M-DV63PROHD tape)

[Connectors]

Video

[HDV]

Video outputs:

Analogue component: Y: 1.0 V (p-p), 75 ohms (BNC)

R-Y/B-Y: 0.7 V (p-p), 75 ohms (BNC)

[DV]

Video inputs:

Analogue composite: 1.0 V (p-p), 75 ohms (BNC)

Analogue Y/C: Y: 1.0 V (p-p), 75 ohms

C: 0.3 V (p-p), 75 ohms (4-pin)

Video outputs:

Analogue composite: 1.0 V (p-p), 75 ohms (BNC)

Analogue Y/C: Y: 1.0 V (p-p), 75 ohms

C: 0.3 V (p-p), 75 ohms (4-pin)

Analogue component: Y: 1.0 V (p-p), 75 ohms (BNC)

R-Y/B-Y: 0.7 V (p-p), 75 ohms (BNC)

Audio

Audio inputs:

Line: -8 dBs, 10 kohms, unbalanced (RCA)

Audio outputs:

Line: -8 dBs, 1 k-ohm, unbalanced (RCA)

Headphones: -∞ to -15 dBs (8 ohms) (Stereo mini jack)

HDMI output: DIN 19-pin

IEEE 1394 interface: 6-pin

RS-422 interface: D-sub 9-pin

Serial remote interface: Mini jack

[Accessories provided]

AC adapter (AA-G30), AC cable

GY-HD110/GY-HD111

Recording/playback format

	Shooting	Tape	IEEE1394	Component out (EE)	Video out
HDV	720p 30	←	←	720p 60	480i 60
	720p 25	←	←	720p 50	576i 50
	720p 23.98	←	←	720p 60	480i 60
	480p 60	←	←	480p 60	480i 60
	576p 50	←	←	576p 50	576i 50
DV	576i 50	←	←	←	576i 50
	576i 50 (25)	←	←	←	576i 50

	Playback	IEEE1394	Component out			Video out
			480 or 576i	480 or 576p	1080i	
HDV	720p 60	←			1080i 60	480i 60
	720p 30	←			1080i 60	480i 60
	720p 50	←			1080i 50	720p 50
	720p 25	←			1080i 50	720p 50
	720p 23.98	←			1080i 60	480i 60
	480p 60	←		480p 60	1080i 60	720p 60
	576p 50	←		576p 50	1080i 50	720p 50
DV	576i 50	←	576i 50			576i 50
	576p 25	←	576i 50			576i 50

	Recording* (IEEE1394 input)	Tape	Component out/HDMI out			Video out
			480 or 576i	480 or 576p	1080i	
HDV	720p 30	←			1080i 60	480i 60
	720p 25	←			1080i 50	720p 50
	720p 23.98	←			1080i 60	480i 60
	480p 60	←		480p 60	1080i 60	720p 60
	576p 50	←		576p 50	1080i 50	720p 50
	576i 50	←				576i 50
DV	576i 50	←	576i 50			576i 50
	576p 50 (25)	←	576i 50			576i 50

BR-HD50

Recording/playback format

	Recording (Analogue output)	Tape	Component out/HDMI out	Video out
DV	576i 50	←	B	576i 50

	Playback	IEEE 1394	Component out/HDMI out	Video out
HDV	720p 60	←	A (Upgrade resulted)	480i 60 (Upgrade resulted)
	720p 30	←	A	480i 60
	720p 50	←	B (Upgrade resulted)	576i 50 (Upgrade resulted)
	720p 25	←	B	576i 50
	720p 23.98	←	A	480i 60
	480p 60	←	A	480i 60
	576p 50	←	B	576i 50
DV	576i 50	←	B	576i 50
	576i 50 (25)	←	B	576i 50

	Recording (IEEE1394 output)	Tape	Component out/HDMI out	Video out
HDV	720p 30	←	A	480i 60
	720p 25	←	B	576i 50
	720p 23.98	←	A	480i 60
	480p 60	←	A	480i 60
	576p 50	←	B	576i 50
	576i 50	←	B	576i 50
DV	576i 50 (25)	←	B	576i 50

A: 720p 60, 480p 60, 1080i 60, 480i 60 B: 720p 50, 576p 50, 1080i 50, 576i 50

Note: 30 = 29.97 Hz 60 = 59.94 Hz

*Tapes recorded in HDV1080i format cannot be played back by GY-HD110 and BR-HD50.

*Impossible with the GY-HD110.

HDV™
HDV 720p

DV



High Performance

High Definition



Multi-functional

Multi-format

Multi-purpose



* HDV™ and HDV™ logo are trademarks of Sony Corporation and Victor Company of Japan, Limited (JVC).
* DVCAM™ is a registered trademark of Sony Corporation.
* DTE™ (Direct to Edit™) is a registered trademark of Focus Enhancements.
* Product and company names mentioned here are trademarks or registered trademarks of their respective owners.

*Simulated pictures.
The values for weight and dimensions are approximate.
E. & O.E. Design and specifications subject to change without notice.*

JVC®

DISTRIBUTED BY



■ Hachioji Business Center of Victor Company of Japan, Ltd. has received ISO14001 and ISO9001 Certifications under the global standard for environmental management.